

KATALOG PRIBORA ZA VRTANJE
 Catalogue of drilling accessories

ŠIFRA
 CODE

SPECIFIKACIJA
 SPECIFICATION

NAZIV ARTIKLA
 PART DESCRIPTION

SLIKA / NAČRT
 PICTURE / DRAWING

01013 Ø 66 mm
 01014 Ø 76 mm
 01015 Ø 86 mm
 01016 Ø 101 mm
 01017 Ø 116 mm
 01018 Ø 131 mm
 01019 Ø 146 mm

VIDIA KRONA TANKA TIP B
T.C. DRILL BIT TYPE B
 VIDIJA KRUNA TANKA TIP B
VIDIJA KRUNA TANKA TIP B



01023 Ø 66 mm
 01024 Ø 76 mm
 01025 Ø 86 mm
 01026 Ø 101 mm
 01027 Ø 116 mm
 01028 Ø 131 mm
 01029 Ø 146 mm

LOVILEC JEDRA TIP B
CORE CATCHER (LIFTER) TYPE B
 HVATAČ JEZGRE TIP B
OPRUGA TANKA SRŽNA TIP B

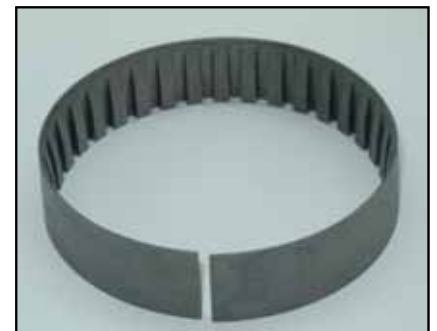

01033 Ø 66 mm
 01034 Ø 76 mm
 01035 Ø 86 mm
 01036 Ø 101 mm
 01037 Ø 116 mm
 01038 Ø 131 mm
 01039 Ø 146 mm

DRŽAČ KRONE TIP B
REAMING SHELL TYPE B
 SPOJNICA TANKE KRUNE TIP B
SPOJNICA TANKE KRUNE TIP B



01053 Ø 66 / 76 mm
 01054 Ø 76 / 86 mm
 01055 Ø 86 / 101 mm
 01056 Ø 101 / 116 mm
 01057 Ø 116 / 131 mm
 01058 Ø 131 / 146 mm
 01059 Ø 146 / 161 mm

RAZŠIRJENA VIDIA KRONA TIP B
EXTENDED T.C. DRILL BIT TYPE B
 VIDIJA KRUNA PROŠIRENA TIP B
VIDIJA KRUNA PROŠIRENA TIP B



02013 Ø 66 mm
 02014 Ø 76 mm
 02015 Ø 86 mm
 02016 Ø 101 mm
 02017 Ø 116 mm
 02018 Ø 131 mm
 02019 Ø 146 mm

VIDIA KRONA TIP Y
T.C. DRILL BIT TYPE Y
 VIDIJA KRUNA DEBELA TIP Y
VIDIJA KRUNA DEBELA TIP Y



KATALOG PRIBORA ZA VRTANJE
 Catalogue of drilling accessories

ŠIFRA
 CODE

SPECIFIKACIJA
 SPECIFICATION

NAZIV ARTIKLA
 PART DESCRIPTION

SLIKA / NAČRT
 PICTURE / DRAWING

03013 Ø 66 mm
 03014 Ø 76 mm
 03015 Ø 86 mm
 03016 Ø 101 mm
 03017 Ø 116 mm
 03018 Ø 131 mm
 03019 Ø 146 mm

VIDIA KRONA TIP SS
T.C. DRILL BIT TYPE SS
 VIDIJA KRUNA SREDNJA TIP SS
VIDIJA KRUNA SREDNJA TIP SS



07194 Ø 76 mm L-1,5 m
 07234 Ø 76 mm L-2 m
 07004 Ø 76 mm L-3 m
 07195 Ø 86 mm L-1,5 m
 07235 Ø 86 mm L-2 m
 07005 Ø 86 mm L-3 m
 07196 Ø 101 mm L-1,5 m
 07236 Ø 101 mm L-2 m
 07006 Ø 101 mm L-3 m
 07197 Ø 116 mm L-1,5 m
 07237 Ø 116 mm L-2 m
 07007 Ø 116 mm L-3 m
 07198 Ø 131 mm L-1,5 m
 07238 Ø 131 mm L-2 m
 07008 Ø 131 mm L-3 m
 07199 Ø 146 mm L-1,5 m
 07239 Ø 146 mm L-2 m
 07009 Ø 146 mm L-3 m

DVOJNI JEDRIK TIP KM
DOUBLE TUBE CORE BARREL TYPE KM
 DVOSTRUKA JEZGRENA CIJEV TIP KM (Muhvić)
DUPLA SRŽNA CEV TIP KM (Muhvić)

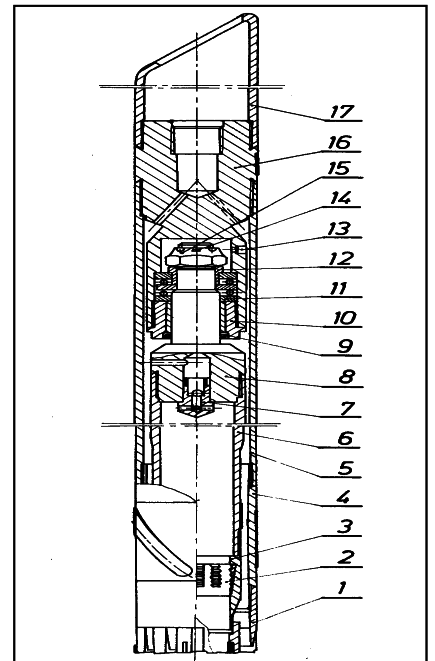

07014 Ø 76 mm
 07015 Ø 86 mm
 07016 Ø 101 mm
 07017 Ø 116 mm
 07018 Ø 131 mm
 07019 Ø 146 mm

VIDIA KRONA TIP KM
T.C. DRILL BIT TYPE KM
 VIDIJA KRUNA TIP KM (Muhvić)
VIDIJA KRUNA TIP KM (Muhvić)



07024 Ø 76 mm
 07025 Ø 86 mm
 07026 Ø 101 mm
 07027 Ø 116 mm
 07028 Ø 131 mm
 07029 Ø 146 mm

LOVILEC JEDRA TIP KM
CORE CATCHER (LIFTER) TYPE KM
 HVATAČ JEZGRE TIP KM
OPRUGA SRŽNA TIP KM



KATALOG PRIBORA ZA VRTANJE
Catalogue of drilling accessories

ŠIFRA
CODE

SPECIFIKACIJA
SPECIFICATION

NAZIV ARTIKLA
PART DESCRIPTION

SLIKA / NAČRT
PICTURE / DRAWING

07034 Ø 76 mm
07035 Ø 86 mm
07036 Ø 101 mm
07037 Ø 116 mm
07038 Ø 131 mm
07039 Ø 146 mm

OHIŠJE LOVILCA TIP KM
HOUSING (CORE LIFTER CASE) TYPE KM
KUĆIŠTE HVATAČA TIP KM
KUĆIŠTE HVATAČA - OPRUGE TIP KM



07044 Ø 76 mm
07045 Ø 86 mm
07046 Ø 101 mm
07047 Ø 116 mm
07048 Ø 131 mm
07049 Ø 146 mm

DRŽAČ KRONE TIP KM
REAMING SHELL TYPE KM
SPOJNICA KRUNE (držač) TIP KM
SPOJNICA KRUNE (držač) TIP KM



07184 Ø 76 / 86 mm
07185 Ø 86 / 101 mm
07186 Ø 101 / 116 mm
07187 Ø 116 / 131 mm
07188 Ø 131 / 146 mm
07189 Ø 146 / 161 mm

RAZŠIRJENA WIDIA KRONA TIP KM
EXTENDED T.C. DRILL BIT TYPE KM
VIDIJA KRUNA PROŠIRENA TIP KM
VIDIJA KRUNA PROŠIRENA TIP KM



07204 Ø 76 mm L-1,5 m
07244 Ø 76 mm L-2 m
07054 Ø 76 mm L-3 m
07205 Ø 86 mm L-1,5 m
07245 Ø 86 mm L-2 m
07055 Ø 86 mm L-3 m
07206 Ø 101 mm L-1,5 m
07246 Ø 101 mm L-2 m
07056 Ø 101 mm L-3 m
07207 Ø 116 mm L-1,5 m
07247 Ø 116 mm L-2 m
07057 Ø 116 mm L-3 m
07208 Ø 131 mm L-1,5 m
07248 Ø 131 mm L-2 m
07058 Ø 131 mm L-3 m
07209 Ø 146 mm L-1,5 m
07249 Ø 146 mm L-2 m
07059 Ø 146 mm L-3 m

ZUNANJA CEV ZA DVOJNI JEDRNIK KM
OUTER TUBE FOR TYPE KM
VANJSKA CIJEV TIP KM (Muhvić)
SPOLJNA CEV TIP KM (Muhvić)



KATALOG PRIBORA ZA VRTANJE
 Catalogue of drilling accessories

ŠIFRA CODE	SPECIFIKACIJA SPECIFICATION	NAZIV ARTIKLA PART DESCRIPTION	SLIKA / NAČRT PICTURE / DRAWING
---------------	--------------------------------	-----------------------------------	------------------------------------

07214	Ø 76 mm L-1,5 m	NOTRANJA CEV ZA DVOJ.JEDRNIK TIP KM	
07254	Ø 76 mm L-2 m	INNER TUBE FOR TYPE KM	
07064	Ø 76 mm L-3 m	UNUTRAŠNJA CIJEV TIP KM (Muhvić)	
07215	Ø 86 mm L-1,5 m	UNUTRAŠNJA CEV TIP KM (Muhvić)	
07255	Ø 86 mm L-2 m		
07065	Ø 86 mm L-3 m		
07216	Ø 101 mm L-1,5 m		
07256	Ø 101 mm L-2 m		
07066	Ø 101 mm L-3 m		
07217	Ø 116 mm L-1,5 m		
07257	Ø 116 mm L-2 m		
07067	Ø 116 mm L-3 m		
07218	Ø 131 mm L-1,5 m		
07258	Ø 131 mm L-2 m		
07068	Ø 131 mm L-3 m		
07219	Ø 146 mm L-1,5 m		
07259	Ø 146 mm L-2 m		
07069	Ø 146 mm L-3 m		



07174	Ø 76 mm	SEDIMENTNA CEV TIP KM	
07175	Ø 86 mm	SEDIMENT TUBE FOR TYPE KM	
07176	Ø 101 mm	SEDIMENT CIJEV TIP KM (Muhvić)	
07177	Ø 116 mm	SEDIMENT CEV TIP KM (Muhvić)	
07178	Ø 131 mm		
07179	Ø 146 mm		



07224	Ø 76 mm	NOTRANJA GLAVA KOMPLET TIP KM	
07225	Ø 86 mm	INNER HEAD COMPLET TYPE KM	
07226	Ø 101 mm	UNUTRAŠNJA GLAVA KOMPLET TIP KM	
07227	Ø 116 mm	UNUTRAŠNJA GLAVA KOMPLET TIP KM	
07228	Ø 131 mm		
07229	Ø 146 mm		



08211	Ø 50 mm	SPOJNICA ZA VRT. DROGOVJE - DESNA COUPLING FOR DRILL RODS - RIGHT SPOJNICA ZA BUŠAĆE ŠIPKE - DESNA SPOJNICA ZA BUŠAĆE ŠIPKE - DESNA	
08231	Ø 50 mm	SPOJNICA ZA VRT. DROGOVJE - LEVA COUPLING FOR DRILL RODS - LEFT SPOJNICA ZA BUŠAĆE ŠIPKE - LIJEVA SPOJNICA ZA BUŠAĆE ŠIPKE - LEVA	



KATALOG PRIBORA ZA VRTANJE
Catalogue of drilling accessories

ŠIFRA CODE	SPECIFIKACIJA SPECIFICATION	NAZIV ARTIKLA PART DESCRIPTION	SLIKA / NAČRT PICTURE / DRAWING
08202	Ø 50 mm L-1 m	VRTALNO DROGOVJE - DESNO	
08203	Ø 50 mm L-1,5 m	DRILL RODS - RIGHT	
08204	Ø 50 mm L-2 m	BUŠAČE ŠIPKE - DESNE	
08205	Ø 50 mm L-2,5 m	BUŠAČE ŠIPKE - DESNE	
08206	Ø 50 mm L-3 m	BUŠAČE ŠIPKE - DESNE	
08222	Ø 50 mm L-1 m	VRTALNO DROGOVJE - LEVO	
08223	Ø 50 mm L-1,5 m	DRILL RODS - LEFT	
08224	Ø 50 mm L-2 m	BUŠAČE ŠIPKE - LIJEVE	
08225	Ø 50 mm L-2,5 m	BUŠAČE ŠIPKE - LEVE	
08226	Ø 50 mm L-3 m	BUŠAČE ŠIPKE - LEVE	
08402	Ø 60,3 mm L-1 m	VRTALNO DROGOVJE S SPOJNICO-DESNO	
08403	Ø 60,3 mm L-1,5 m	DRILL RODS WITH COUPLING - RIGHT	
08404	Ø 60,3 mm L-2 m	BUŠAČE ŠIPKE SA SPOJNICOM - DESNE	
08405	Ø 60,3 mm L-2,5 m	BUŠAČE ŠIPKE SA SPOJNICOM - DESNE	
08406	Ø 60,3 mm L-3 m	BUŠAČE ŠIPKE SA SPOJNICOM - DESNE	
08502	Ø 73 mm L-1 m	VRTALNO DROGOVJE S SPOJNICO-LEVO	
08503	Ø 73 mm L-1,5 m	DRILL RODS WITH COUPLING - LEFT	
08504	Ø 73 mm L-2 m	BUŠAČE ŠIPKE SA SPOJNICOM - LIJEVE	
08505	Ø 73 mm L-2,5 m	BUŠAČE ŠIPKE SA SPOJNICOM - LEVE	
08506	Ø 73 mm L-3 m	BUŠAČE ŠIPKE SA SPOJNICOM - LEVE	
08422	Ø 60,3 mm L-1 m	VRTALNO DROGOVJE S SPOJNICO-LEVO	
08423	Ø 60,3 mm L-1,5 m	DRILL RODS WITH COUPLING - LEFT	
08424	Ø 60,3 mm L-2 m	BUŠAČE ŠIPKE SA SPOJNICOM - LIJEVE	
08425	Ø 60,3 mm L-2,5 m	BUŠAČE ŠIPKE SA SPOJNICOM - LEVE	
08426	Ø 60,3 mm L-3 m	BUŠAČE ŠIPKE SA SPOJNICOM - LEVE	
08522	Ø 73 mm L-1 m	VRTALNO DROGOVJE S SPOJNICO-LEVO	
08523	Ø 73 mm L-1,5 m	DRILL RODS WITH COUPLING - LEFT	
08524	Ø 73 mm L-2 m	BUŠAČE ŠIPKE SA SPOJNICOM - LIJEVE	
08525	Ø 73 mm L-2,5 m	BUŠAČE ŠIPKE SA SPOJNICOM - LEVE	
08526	Ø 73 mm L-3 m	BUŠAČE ŠIPKE SA SPOJNICOM - LEVE	
08410	Ø 60,3 mm (GZ-60)	KLJUČ ZA VRTALNO DROGOVJE	
08510	Ø 73 mm (GZ-60)	PIPE TONGS FOR DRILL RODS KLJUČ ZA BUŠAČE ŠIPKE KLJUČ ZA BUŠAČE ŠIPKE	

KATALOG PRIBORA ZA VRTANJE
Catalogue of drilling accessories

ŠIFRA CODE	SPECIFIKACIJA SPECIFICATION	NAZIV ARTIKLA PART DESCRIPTION	SLIKA / NAČRT PICTURE / DRAWING
09013	Ø 64 mm L-0,5 m	JEDRNA CEV	
09014	Ø 74 mm L-0,5 m	CORE TUBE	
09015	Ø 84 mm L-0,5 m	JEZGRENA CIJEV	
09016	Ø 98 mm L-0,5 m	SRŽNA CEV	
09017	Ø 113 mm L-0,5 m		
09018	Ø 128 mm L-0,5 m		
09019	Ø 143 mm L-0,5 m		
09133	Ø 64 mm L-1 m	JEDRNA CEV	
09134	Ø 74 mm L-1 m	CORE TUBE	
09135	Ø 84 mm L-1 m	JEZGRENA CIJEV	
09136	Ø 98 mm L-1 m	SRŽNA CEV	
09137	Ø 113 mm L-1 m		
09138	Ø 128 mm L-1 m		
09139	Ø 143 mm L-1 m		
09023	Ø 64 mm L-1,5 m	JEDRNA CEV	
09024	Ø 74 mm L-1,5 m	CORE TUBE	
09025	Ø 84 mm L-1,5 m	JEZGRENA CIJEV	
09026	Ø 98 mm L-1,5 m	SRŽNA CEV	
09027	Ø 113 mm L-1,5 m		
09028	Ø 128 mm L-1,5 m		
09029	Ø 143 mm L-1,5 m		
09143	Ø 64 mm L-2 m	JEDRNA CEV	
09144	Ø 74 mm L-2 m	CORE TUBE	
09145	Ø 84 mm L-2 m	JEZGRENA CIJEV	
09146	Ø 98 mm L-2 m	SRŽNA CEV	
09147	Ø 113 mm L-2 m		
09148	Ø 128 mm L-2 m		
09149	Ø 143 mm L-2 m		
09033	Ø 64 mm L-3 m	JEDRNA CEV	
09034	Ø 74 mm L-3 m	CORE TUBE	
09035	Ø 84 mm L-3 m	JEZGRENA CIJEV	
09036	Ø 98 mm L-3 m	SRŽNA CEV	
09037	Ø 113 mm L-3 m		
09038	Ø 128 mm L-3 m		
09039	Ø 143 mm L-3 m		
09153	Ø 64 mm	SPOJNICA JEDRNA CEV / JEDRNA CEV	
09154	Ø 74 mm	COUPLING CORE TUBE / CORE TUBE	
09155	Ø 84 mm	SPOJNICA JEZGRENA / JEZGRENA CIJEV	
09156	Ø 98 mm	SPOJNICA SRŽNA / SRŽNU CEV	
09157	Ø 113 mm		
09158	Ø 128 mm		
09159	Ø 143 mm		

KATALOG PRIBORA ZA VRTANJE
 Catalogue of drilling accessories

ŠIFRA
 CODE

SPECIFIKACIJA
 SPECIFICATION

NAZIV ARTIKLA
 PART DESCRIPTION

SLIKA / NAČRT
 PICTURE / DRAWING

09063 Ø 64 X 50 mm
 09064 Ø 74 X 50 mm
 09065 Ø 84 X 50 mm
 09066 Ø 98 X 50 mm
 09067 Ø 113 X 50 mm
 09068 Ø 128 X 50 mm
 09069 Ø 143 X 50 mm
 09073 Ø 64 X 60,3 mm
 09074 Ø 74 X 60,3 mm
 09075 Ø 84 X 60,3 mm
 09076 Ø 98 X 60,3 mm
 09077 Ø 113 X 60,3 mm
 09078 Ø 128 X 60,3 mm
 09079 Ø 143 X 60,3 mm

JEDERNA GLAVA
 CORE HEAD
 GLAVA JEZGRENE CIJEVI (na bušaču šipku)
 GLAVA SRŽNE CEVI (na bušaču šipku)



09083 Ø 64 mm L-1 m
 09084 Ø 74 mm L-1 m
 09085 Ø 84 mm L-1 m
 09086 Ø 98 mm L-1 m
 09087 Ø 113 mm L-1 m
 09088 Ø 128 mm L-1 m
 09089 Ø 143 mm L-1 m

SEDIMENTNA CEV
 SEDIMENT TUBE
 SEDIMENT CIJEV
 SEDIMENT CEV



09113 Ø 64 / 64 X 50 mm
 09114 Ø 74 / 74 X 50 mm
 09115 Ø 84 / 84 X 50 mm
 09116 Ø 98 / 98 X 50 mm
 09117 Ø 113 / 113 X 50 mm
 09118 Ø 128 / 128 X 50 mm
 09119 Ø 143 / 143 X 50 mm
 09123 Ø 64 / 64 X 60,3 mm
 09124 Ø 74 / 74 X 60,3 mm
 09125 Ø 84 / 84 X 60,3 mm
 09126 Ø 98 / 98 X 60,3 mm
 09127 Ø 113 / 113 X 60,3 mm
 09128 Ø 128 / 128 X 60,3 mm
 09129 Ø 143 / 143 X 60,3 mm

GLAVA JEDRNE IN SEDIMENTNE CEVI
 CORE / SEDIMENT HEAD
 GLAVA JEZGRENE I SEDIMENTNE CIJEVI
 GLAVA SRŽNE I SEDIMENTNE CEVI



09167 Ø 113 X 50 mm

NABIJALNA GLAVA
 HEAD
 NABIJALNA GLAVA (spojnica)
 NABIJALNA GLAVA (spojnica)



ŠIFRA CODE	SPECIFIKACIJA SPECIFICATION	NAZIV ARTIKLA PART DESCRIPTION	SLIKA / NAČRT PICTURE / DRAWING
10063	Ø 64 mm L-0,5 m	OBLOŽNA CEV	
10064	Ø 74 mm L-0,5 m	CASING TUBE	
10065	Ø 84 mm L-0,5 m	OBLOŽNA CIJEV	
10066	Ø 98 mm L-0,5 m	OBLOŽNA CEV - KOLONA	
10067	Ø 113 mm L-0,5 m		
10068	Ø 128 mm L-0,5 m		
10069	Ø 143 mm L-0,5 m		
10073	Ø 64 mm L-1 m	OBLOŽNA CEV	
10074	Ø 74 mm L-1 m	CASING TUBE	
10075	Ø 84 mm L-1 m	OBLOŽNA CIJEV	
10076	Ø 98 mm L-1 m	OBLOŽNA CEV - KOLONA	
10077	Ø 113 mm L-1 m		
10078	Ø 128 mm L-1 m		
10079	Ø 143 mm L-1 m		
10083	Ø 64 mm L-1,5 m	OBLOŽNA CEV	
10084	Ø 74 mm L-1,5 m	CASING TUBE	
10085	Ø 84 mm L-1,5 m	OBLOŽNA CIJEV	
10086	Ø 98 mm L-1,5 m	OBLOŽNA CEV - KOLONA	
10087	Ø 113 mm L-1,5 m		
10088	Ø 128 mm L-1,5 m		
10089	Ø 143 mm L-1,5 m		
10093	Ø 64 mm L-2 m	OBLOŽNA CEV	
10094	Ø 74 mm L-2 m	CASING TUBE	
10095	Ø 84 mm L-2 m	OBLOŽNA CIJEV	
10096	Ø 98 mm L-2 m	OBLOŽNA CEV - KOLONA	
10097	Ø 113 mm L-2 m		
10098	Ø 128 mm L-2 m		
10099	Ø 143 mm L-2 m		
10013	Ø 64 mm L-3 m	OBLOŽNA CEV	
10014	Ø 74 mm L-3 m	CASING TUBE	
10015	Ø 84 mm L-3 m	OBLOŽNA CIJEV	
10016	Ø 98 mm L-3 m	OBLOŽNA CEV - KOLONA	
10017	Ø 113 mm L-3 m		
10018	Ø 128 mm L-3 m		
10019	Ø 143 mm L-3 m		
10042	Ø 54 X 50 mm	GLAVA ZA OBLOŽNE CEVI	
10043	Ø 64 X 50 mm	HEAD FOR CASING TUBE	
10044	Ø 74 X 50 mm	GLAVA OBLOŽNE CIJEVI	
10045	Ø 84 X 50 mm	GLAVA OBLOŽNE CEVI	
10046	Ø 98 X 50 mm		
10047	Ø 113 X 50 mm		
10048	Ø 128 X 50 mm		
10049	Ø 143 X 50 mm		
10053	Ø 64 X 60,3 mm		
10054	Ø 74 X 60,3 mm		
10055	Ø 84 X 60,3 mm		
10056	Ø 98 X 60,3 mm		
10057	Ø 113 X 60,3 mm		
10058	Ø 128 X 60,3 mm		
10059	Ø 143 X 60,3 mm		

ŠIFRA CODE	SPECIFIKACIJA SPECIFICATION	NAZIV ARTIKLA PART DESCRIPTION	SLIKA / NAČRT PICTURE / DRAWING
23101	Ø 146 / 101 mm	VIDIA KRONA SK6L RAVNI PROFIL <i>T.C. DRILL BIT SK6L FLAT PROFILE</i> VIDIJA KRUNA SK6L RAVNI PROFIL <i>VIDIJA KRUNA SK6L RAVNI PROFIL</i>	
23102	Ø 146 / 101 mm	VIDIA KRONA SQ-3 RAVNI PROFIL <i>T.C. DRILL BIT SQ-3 FLAT PROFILE</i> VIDIJA KRUNA SQ-3 RAVNI PROFIL <i>VIDIJA KRUNA SQ-3 RAVNI PROFIL</i>	
23103	Ø 146 / 101 mm	VIDIA KRONA SQ RAVNI PROFIL <i>T.C. DRILL BIT SQ FLAT PROFILE</i> VIDIJA KRUNA SQ RAVNI PROFIL <i>VIDIJA KRUNA SQ RAVNI PROFIL</i>	
23111	Ø 146 / 101 mm	VIDIA KRONA SK6L PILOT PROFIL <i>T.C. DRILL BIT SK6L PILOT PROFILE</i> VIDIJA KRUNA SK6L PILOT PROFIL <i>VIDIJA KRUNA SK6L PILOT PROFIL</i>	
23112	Ø 146 / 101 mm	VIDIA KRONA SQ-3 PILOT PROFIL <i>T.C. DRILL BIT SQ-3 PILOT PROFILE</i> VIDIJA KRUNA SQ-3 PILOT PROFIL <i>VIDIJA KRUNA SQ-3 PILOT PROFIL</i>	
23113	Ø 146 / 101 mm	VIDIA KRONA SQ PILOT PROFIL <i>T.C. DRILL BIT SQ PILOT PROFILE</i> VIDIJA KRUNA SQ PILOT PROFIL <i>VIDIJA KRUNA SQ PILOT PROFIL</i>	
23114	Ø 146 mm	VIDIA KRONA TIP SWF <i>T.C. DRILL BIT TYPE SWF</i> VIDIJA KRUNA TIP SWF <i>VIDIJA KRUNA TIP SWF</i>	
10104	Ø 76 mm	OBLO.VIDIA KRONA DESNA (CASING BIT) <i>T.C. CASING BIT - RIGHT</i> OBLO.VIDIJA KRUNA - DESNA <i>OBLO.VIDIJA KRUNA - DESNA</i>	
10105	Ø 86 mm		
10106	Ø 101 mm		
10107	Ø 116 mm		
10108	Ø 131 mm		
10109	Ø 146 mm		
10110	Ø 160 mm		
10111	Ø 163 mm		
10112	Ø 178 mm		
10113	Ø 183 mm		
10204	Ø 76 mm	OBLO.VIDIA KRONA LEVA (CASING BIT) <i>T.C. CASING BIT - LEFT</i> OBLO.VIDIJA KRUNA - LIJEVA <i>OBLO.VIDIJA KRUNA - LEVA</i>	
10205	Ø 86 mm		
10206	Ø 101 mm		
10207	Ø 116 mm		
10208	Ø 131 mm		
10209	Ø 146 mm		
10210	Ø 160 mm		
10211	Ø 163 mm		
10212	Ø 178 mm		
10213	Ø 183 mm		

KATALOG PRIBORA ZA VRTANJE
Catalogue of drilling accessories

ŠIFRA CODE	SPECIFIKACIJA SPECIFICATION	NAZIV ARTIKLA PART DESCRIPTION	SLIKA / NAČRT PICTURE / DRAWING	
10304	Ø 76 mm	OBL.VIDIA KRONA DESNA (CASING SHOE)		
10305	Ø 86 mm	<i>T.C. CASING SHOE - RIGHT</i>		
10306	Ø 101 mm	OBLO.VIDIJA KRUNA - DESNA		
10307	Ø 116 mm	<i>OBLO.VIDIJA KRUNA - DESNA</i>		
10308	Ø 131 mm			
10309	Ø 146 mm			
10310	Ø 160 mm			
10311	Ø 163 mm			
10312	Ø 178 mm			
10313	Ø 183 mm			
10404	Ø 76 mm	OBL.VIDIA KRONA LEVA (CASING SHOE)		
10405	Ø 86 mm	<i>T.C. CASING SHOE - LEFT</i>		
10406	Ø 101 mm	OBLO.VIDIJA KRUNA - LIJEVA		
10407	Ø 116 mm	<i>OBLO.VIDIJA KRUNA - LEVA</i>		
10408	Ø 131 mm			
10409	Ø 146 mm			
10410	Ø 160 mm			
10411	Ø 163 mm			
10412	Ø 178 mm			
10413	Ø 183 mm			
08604	Ø 136 mm	VIDIA KRONA TIP SMC - LEVA		
08614	Ø 156 mm	<i>T.C. DRILL BIT TYPE SMC - LEFT</i>		
08605	Ø 136 mm	VIDIA KRONA TIP SMC - DESNA		
08615	Ø 156 mm	<i>T.C. DRILL BIT TYPE SMC - RIGHT</i>		
08606	Ø 136 mm	DRŽAČ KRONE TIP SMC - LEVI		
08616	Ø 156 mm	<i>REAMING SHELL TYPE SMC - LEFT</i>		
08607	Ø 136 mm	DRŽAČ KRONE TIP SMC - DESNI		
08617	Ø 156 mm	<i>REAMING SHELL TYPE SMC - RIGHT</i>		
08627	Ø 142 mm	SPOJNICA KRUNE TIP SMC - DESNA		
19101	Ø 98 mm	CILINDER ZA INTAKTNE VZORCE <i>CYLINDER FOR INTACT SAMPLES</i> CILINDAR ZA NEPOREMEČENE UZORKE <i>CILINDAR ZA NEPOREMEČENE UZORKE</i>		

KATALOG PRIBORA ZA VRTANJE
 Catalogue of drilling accessories

ŠIFRA SPECIFIKACIJA
 CODE SPECIFICATION

NAZIV ARTIKLA
 PART DESCRIPTION

SLIKA / NAČRT
 PICTURE / DRAWING

19001 Ø 113 mm

CILINDER ZA INTAKTNE VZORCE-DVODELNI
 CYLINDER FOR INTACT SAMPLES-DOUBLE
 DVODJELNI CILINDAR ZA NEPOR.UZORKE
 DVODELNI CILINDAR ZA NEPOR.UZORKE



19111 Ø 98 mm
 19011 Ø 113 mm

NOŽ ZA INTAKTNE VZORCE
 CUTTER FOR INTACT SAMPLES
 NOŽ ZA INTAKTNE UZORKE
 NOŽ ZA INTAKTNE UZORKE



19121 Ø 98 mm
 19021 Ø 113 mm

PLASTIČNI VLOŽEK
 PVC INSERTER
 PLASTIČNI ULOŽAK
 PLASTIČNI ULOŽAK



30001 Ø 95 mm
 30002 Ø 105 mm
 30003 Ø 115 mm
 30004 Ø 150 mm
 30005 Ø 175 mm
 30006 Ø 250 mm

STOPNIČASTO ROTACIJSKO DLETO KOMPLET
 MULTI-STAGE ROTARY BITS COMPLET
 STEPENASTO ROTACIONO DLIJETO KOMPLET
 STEPENASTO ROTACIONO DLIJETO KOMPLET



30031 Ø 95 mm
 30032 Ø 105 mm
 30033 Ø 115 mm
 30034 Ø 150 mm
 30035 Ø 175 mm
 30036 Ø 250 mm

TELO DLETA ZA STOPNIČASTO ROT.DLETO
 BODY FOR MULTI-STAGE ROTARY BITS
 TELO DLIJETA ZA STEPEN. ROT.DLETA
 TELO DLETA ZA STEPEN. ROT.DLETA





ŠIFRA CODE	SPECIFIKACIJA SPECIFICATION	NAZIV ARTIKLA PART DESCRIPTION	SLIKA / NAČRT PICTURE / DRAWING
---------------	--------------------------------	-----------------------------------	------------------------------------

30020	Ø 85 mm	RAZŠIRJEVALEC (SEGMENT)	
30021	Ø 95 mm	RING TYPE REAMER	
30022	Ø 105 mm	PROŠIRIVAČ (SEGMENT)	
30023	Ø 115 mm	PROŠIRIVAČ (SEGMENT)	
30024	Ø 125 mm		
30025	Ø 150 mm		
30026	Ø 175 mm		
30027	Ø 200 mm		
30028	Ø 225 mm		
30029	Ø 250 mm		

30012	Ø 65 mm	PILOT DLETO TIP TKD	
30015	Ø 95 mm	PILOT BIT TYPE TKD (THREE - WING) PILOT DLIJETO TIP TKD PILOT DLETO TIP TKD	

30040		PRSTAN MANJŠI NON-CUTTING RING (SMALLER) PRSTEN MANJI PRSTEN MANJI	
30041		PRSTAN VEČJI NON-CUTTING RING (BIGGER) PRSTEN VEČI PRSTEN VEČI	

31002	Ø 65 mm X 50 mm	TROKRILNO DLETO TIP TKD	
31003	Ø 75 mm X Hausher	THREE-WING SINGLE STAGE BIT TYPE TKD	
31004	Ø 85 mm X Hausher	TROKRILNO DLIJETO TIP TKD	
31005	Ø 95 mm X Hausher	TROKRILNO DLETO TIP TKD	
31006	Ø 102 mm X Hausher		

31102	Ø 120 mm / Wirth 73 Ž	TROKRILNO DLETO TIP TKD THREE-WING SINGLE STAGE BIT TYPE TKD TROKRILNO DLIJETO TIP TKD TROKRILNO DLETO TIP TKD	
-------	-----------------------	---	---

ŠIFRA CODE	SPECIFIKACIJA SPECIFICATION	NAZIV ARTIKLA PART DESCRIPTION	SLIKA / NAČRT PICTURE / DRAWING
---------------	--------------------------------	-----------------------------------	------------------------------------

32001	Ø 90 mm (2 3/8" reg.)	ŠTIRIKRILNO DLETO TIP ŠKD	
32002	Ø 95 mm (2 3/8" reg.)	FOUR-WING SINGLE STAGE BIT TYPE ŠKD	
32003	Ø 102 mm (2 3/8" reg.)	ČETVOROKRILNO DLIJETO TIP ŠKD	
32004	Ø 105 mm (2 3/8" reg.)	ČETVOROKRILNO DLETO TIP ŠKD	
32005	Ø 112 mm (2 3/8" reg.)		
32006	Ø 115 mm (2 3/8" reg.)		
32007	Ø 130 mm (2 3/8" reg.)		

32104	Ø 146 mm/Wirth 73 M/Ž	ŠTIRIKRILNO DLETO TIP ŠKD - FRITZ	
32107	Ø 176 mm/Wirth 73 M/Ž	FOUR-WING SINGLE STAGE BIT - FRITZ	
		ČETVOROKRILNO DLIJETO TIP ŠKD-FRITZ	
32105	Ø 176 mm	ŠTIRIKRILNO DLETO TIP ŠKD FOUR-WING SINGLE STAGE BIT TYPE ŠKD ČETVOROKRILNO DLIJETO TIP ŠKD ČETVOROKRILNO DLETO TIP ŠKD	

63017	Ø 76 mm navoj T 38	POVR.(RETRO) BRADAVIČ.DLE.ZA UD.VRT.	
64017	Ø 76 mm navoj T 45	BUTTON TYPE BIT WITH BACK RIDGES	
64018	Ø 89 mm navoj T 45	POVR.(RETRO) BRADAVIČ.DLIJ.ZA UD.BUŠ.	
64020	Ø 82 mm navoj T 45	POVR.(RETRO) BRADAVIČ.DLE.ZA UD.BUŠ.	
65018	Ø 89 mm navoj T 51		
65020	Ø 82 mm navoj T 51		
65021	Ø 85 mm navoj T 51		

69051	Ø 32 mm KONUS	MONOBLOK DLETO	
69052	Ø 34 mm KONUS	MONOBLOCK DRILL BIT MONOBLOK DLIJETO MONOBLOK DLETO	

68141	Ø 32 mm NAVOJ	KRIŽNO MONOBLOK DLETO - NAVOJ	
68142	Ø 34 mm NAVOJ	CROSSED MONOBLOCK DRILL BIT (thread)	
68143	Ø 36 mm NAVOJ	KRIŽNO MONOBLOK DLIJETO - NAVOJ	
68144	Ø 38 mm NAVOJ	KRSTASTO MONOBLOK DLETO - NAVOJ	
68145	Ø 40 mm NAVOJ		
68146	Ø 42 mm NAVOJ		
68147	Ø 45 mm NAVOJ		

KATALOG PRIBORA ZA VRTANJE
 Catalogue of drilling accessories

ŠIFRA SPECIFIKACIJA
 CODE SPECIFICATION

NAZIV ARTIKLA
 PART DESCRIPTION

SLIKA / NAČRT
 PICTURE / DRAWING

69141 Ø 32 mm KONUS
 69142 Ø 34 mm KONUS
 69143 Ø 36 mm KONUS
 69144 Ø 38 mm KONUS
 69145 Ø 40 mm KONUS
 69146 Ø 42 mm KONUS
 69147 Ø 45 mm KONUS

KRIŽNO MONOBLOK DLETON - KONUS
CROSSED MONOBLOCK DRILL BIT (conus)
 KRIŽNO MONOBLOK DLIJETO - KONUS
KRSTASTO MONOBLOK DLETO - KONUS



80011 Ø 42 mm, VP
 80012 Ø 42 mm, VK
 80013 Ø 45 mm, VP
 80014 Ø 45 mm, VK

VRTALNA KRONA ZA PREMOG IN KAMEN
DRILL BIT FOR COAL AND ROCK
 BUŠAČA KRUNA ZA UGALJ I KAMEN
BUŠAČA KRUNA ZA UGALJ I KAMEN



90051 EICKHOFF (NR.05)

NOŽ ZA ODKOPNE STROJE
FLAT CUTTER FOR MINING MACHINES
 NOŽ ZA ODKOPNE STROJEVE
NOŽ ZA ODKOPNE MAŠINE



90071 U 47 (NO.01)

NOŽ ZA ODKOPNE STROJE
CONICAL CUTTER FOR MINING MACHINES
 NOŽ ZA ODKOPNE STROJEVE
NOŽ ZA ODKOPNE MAŠINE



90214 C-3

NOŽ ZA ODKOPNE STROJE
CONICAL CUTTER FOR MINING MACHINES
 NOŽ ZA ODKOPNE STROJEVE
NOŽ ZA ODKOPNE MAŠINE



ŠIFRA SPECIFIKACIJA
 CODE SPECIFICATION

NAZIV ARTIKLA
 PART DESCRIPTION

SLIKA / NAČRT
 PICTURE / DRAWING

40011 Ø 50 mm
 40012 Ø 60,3 mm
 40013 Ø 73 mm

KLEŠČE MARTINKE ZA VRT.DROGOVJE
TONGS TYPE MARTINKE FOR DRILL RODS
 KLIJEŠTA MARTINKE ZA BUŠAČE ŠIPKE
KLEŠTA MARTINKE ZA BUŠAČE ŠIPKE



40021 Ø 50 mm
 40022 Ø 60,3 mm
 40023 Ø 73 mm

ČELJUSTI ZA KLEŠČE MARTINKE
JAWS FOR TONGS TYPE MARTINKE
 ČELJUSTI ZA KLIJEŠTA MARTINKE
ČELJUSTI ZA KLEŠTA MARTINKE



41011 Ø 50 mm
 41012 Ø 60,3 mm

ROČNE ŽABE ZA VRTALNO DROGOVJE
SAFETY HAND CLAMP FOR DRILL RODS
 RUČNI STOL ZA BUŠAČE ŠIPKE
RUČNI STOL ZA BUŠAČE ŠIPKE



41021 Ø 50 mm
 41022 Ø 60,3 mm

ČELJUSTI ZA ROČNE ŽABE (PAR)
JAWS FOR HAND CLAMP (PAIR)
 ČELJUSTI RUČNOG STOLA (PAR)
ČELJUSTI RUČNOG STOLA (PAR)





42110 10T / 250 l/min

IZPIRNA GLAVA TIP J10
WATER SWIVEL TYPE J10
 ISPIRNA GLAVA TIP J10
ISPIRNA GLAVA TIP J10



KATALOG PRIBORA ZA VRTANJE
Catalogue of drilling accessories

ŠIFRA CODE	SPECIFIKACIJA SPECIFICATION	NAZIV ARTIKLA PART DESCRIPTION	SLIKA / NAČRT PICTURE / DRAWING
42120	10T / 250 l/min	PRETOČNA CEV ZA J10 <i>SPINDLE TUBE TYPE J10</i> PROTOČNA CIJEV ZA J10 <i>PROTOČNA CEV ZA J10</i>	
42130	10T / 250 l/min	TESNILNI SET ZA J10 <i>RING SET TYPE J10</i> KOMPLET BRTVILA ZA J10 <i>KOMPLET BRTVILA ZA J10</i>	
42210	Ø 92 mm	IZPIRNA GLAVA ZA JAMSKO VRTANJE <i>WATER SWIVEL TYPE MINING</i> ISPIRNA GLAVA ZA JAMSKO BUŠENJE <i>ISPIRNA GLAVA ZA JAMSKO BUŠENJE</i>	
42220	Ø 92 mm	PRETOČNA CEV ZA GLAVO <i>HEAD SPINDLE TUBE</i> PRETOČNA CIJEV ZA GLAVU <i>PRETOČNA CEV ZA GLAVU</i>	
42230	Ø 92 mm	TESNILNI SET ZA GLAVO <i>HEAD RING SET</i> KOMPLET BRTVILA ZA GLAVU <i>KOMPLET BRTVILA ZA GLAVU</i>	
42310	3T / 250 l/min	IZPIRNA GLAVA TIP 3T <i>WATER SWIVEL TYPE 3T</i> IZPIRNA GLAVA TIP 3T <i>IZPIRNA GLAVA TIP 3T</i>	
42320	3T / 250 l/min	PRETOČNA CEV ZA 3T <i>SPINDLE TUBE TYPE 3T</i> PROTOČNA CIJEV ZA 3T <i>PROTOČNA CEV ZA 3T</i>	
43011	Ø 50 mm	IZVLAKAČ ZA VRTALNO DROGOVJE-DESNI <i>HOISTING PLUG - RIGHT</i> IZVLAKAČ ZA BUŠAČE ŠIPKE - DESNI <i>IZVLAKAČ ZA BUŠAČE ŠIPKE - DESNI</i>	
43012	Ø 60,3 mm		
43013	Ø 73 mm		
43021	Ø 50 mm	IZVLAKAČ ZA VRTALNO DROGOVJE-LEVI <i>HOISTING PLUG - LEFT</i> IZVLAKAČ ZA BUŠAČE ŠIPKE - LIJEVI <i>IZVLAKAČ ZA BUŠAČE ŠIPKE - LEVI</i>	
43022	Ø 60,3 mm		
43023	Ø 73 mm		

KATALOG PRIBORA ZA VRTANJE
Catalogue of drilling accessories

ŠIFRA SPECIFIKACIJA
CODE SPECIFICATION

NAZIV ARTIKLA
PART DESCRIPTION

SLIKA / NAČRT
PICTURE / DRAWING

43101 Ø 50 mm
43102 Ø 60,3 mm
43103 Ø 73 mm
43104 Ø 88,9 mm

VRTLJIVO OBESILO TIP VO ZA VR.DR. DESNI
HOISTING PLUG TYPE VO - RIGHT
VIRBL OBESILO TIP VO ZA BUŠ.ŠIP.- DESNI
VIRBL OBESILO TIP VO ZA BUŠ.ŠIP.- DESNI



44011 Ø 50 mm
44012 Ø 60,3 mm
44013 Ø 73 mm

ZVON ZA VRTALNO DROGOVJE - DESNI
BELL TAP FOR DRILL RODS - RIGHT
ZVONO ZA SPAŠAVANJE - BUŠ. ŠIPKE DESNE
ZVONO ZA SPAŠAVANJE - BUŠ. ŠIPKE DESNE



44021 Ø 50 mm
44022 Ø 60,3 mm
44023 Ø 73 mm

ZVON ZA VRTALNO DROGOVJE - LEVI
BELL TAP FOR DRILL RODS - LEFT
ZVONO ZA SPAŠAVANJE - BUŠ. ŠIPKE LIJEVE
ZVONO ZA SPAŠAVANJE - BUŠ. ŠIPKE LEVE

45011 Ø 50 mm
45012 Ø 60,3 mm
45013 Ø 73 mm

KOREN ZA VRTALNO DROGOVJE - DESNI
ROD-RECOVERING TAP (RIGHT)
GLAVA ZA SPAŠAVANJE - BUŠ.ŠIPKE DESNE
GLAVA ZA SPAŠAVANJE - BUŠ.ŠIPKE DESNE



45021 Ø 50 mm
45022 Ø 60,3 mm
45023 Ø 73 mm

KOREN ZA VRTALNO DROGOVJE - LEVI
ROD-RECOVERING TAP (LEFT)
GLAVA ZA SPAŠAVANJE - BUŠ.ŠIPKE LIJEVE
GLAVA ZA SPAŠAVANJE - BUŠ.ŠIPKE LEVE



47011 Ø 50 mm
47012 Ø 60,3 mm
47013 Ø 73 mm

ČELJUSTI ZA MEHAN.STEZ.GLAVO J-600
JAW FOR HEAD TYPE J-600
ČELJUSTI ZA MEHAN.STEZ.GLAVU J-600
ČELJUSTI ZA MEHAN.STEZ.GLAVU J-600

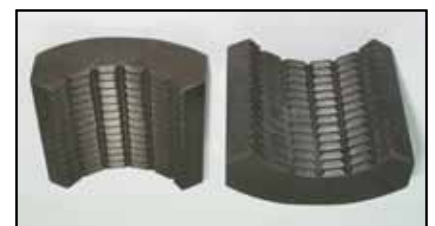

47021 Ø 50 mm
47022 Ø 60,3 mm
47023 Ø 73 mm

VIJAK Z MATICO ZA MEHAN.STE.GL. J-602
SCREW NUT FOR HEAD TYPE J-602
ŠARAF SA MATICOM ZA MEHAN.STE.GL. J-602
ŠARAF SA MATICOM ZA MEHAN.STE.GL. J-602



KATALOG PRIBORA ZA VRTANJE
Catalogue of drilling accessories

ŠIFRA CODE	SPECIFIKACIJA SPECIFICATION	NAZIV ARTIKLA PART DESCRIPTION	SLIKA / NAČRT PICTURE / DRAWING
---------------	--------------------------------	-----------------------------------	------------------------------------

47031 Ø 73 mm
47032 Ø 101 mm

KLJUČ STEZNE VRTALNE GLAVE J-601
HEAD PIPE TONGS FOR TYPE J-601
KLJUČ BUŠAČE STEZNE GLAVE J-601
KLJUČ BUŠAČE STEZNE GLAVE J-601

47110

PENETROMETERSKA PRIPRAVA SPT-1
PENETRABLE DEVICE TYPE SPT-1
PENETROMETARSKA SPRAVA SPT-1
PENETROMETARSKA SPRAVA SPT-1



47120 Ø 50 mm L-0,5 m

DELJIVA SONDA TIP SPLIT
SONDA TYPE SPLIT
DELJIVA SONDA TIP SPLIT
DELIVA SONDA TIP SPLIT



47121

NOŽ ZA SONDO TIP SPLIT
CUTTER FOR SONDA TYPE SPLIT
NOŽ ZA SONDU TIP SPLIT
NOŽ ZA SONDU TIP SPLIT



47130 Ø 50 mm L-0,5 m

SONDA ZA SPT
SONDA FOR SPT
SONDA ZA SPT
SONDA ZA SPT



KATALOG PRIBORA ZA VRTANJE
 Catalogue of drilling accessories

ŠIFRA CODE	SPECIFIKACIJA SPECIFICATION	NAZIV ARTIKLA PART DESCRIPTION	SLIKA / NAČRT PICTURE / DRAWING
47131	Ø 50 mm	KONICA ZA SONDO - NAVOJ <i>SONDA POINTER - THREAD</i> ŠILJAK ZA SONDU - NAVOJ <i>ŠPICA ZA SONDU - NAVOJ</i>	
47140	Ø 36 / Ø 16 mm L-1m	PENETROMETRSKI DROG M / Ž - navoj <i>PENETRABLE ROD PIN / BOX - thread</i> PENETROMETARSKA ŠIPKA M / Ž - navoj <i>PENETROMETARSKA ŠIPKA M / Ž - navoj</i>	
47910	št. 21123	AMORTIZER ZA GRABILEC <i>ABSORBER FOR RAKE</i> AMORTIZER ZA GRAJFER <i>AMORTIZER ZA GRAJFER</i>	
47920	št. 43094	CILINDER GRABILCA <i>CYLINDER RAKE</i> CILINDAR GRAJFERA <i>CILINDAR GRAJFERA</i>	
47930	št. 43093	UVOD ZA GRABILEC <i>PREFACE FOR RAKE</i> MATICA ZA GRAJFER <i>MATICA ZA GRAJFER</i>	
47940	št. 42634	ZASKOČNIK GRABILCA <i>RAKE INTERCEPTER</i>	
47941	št. 43565	KLAPNA ZA GRAJFER <i>KLAPNA ZA GRAJFER</i>	
47950		KLIN CEVI "BENOTTO" <i>SPIKE TUBE "BENOTTO"</i> KLIN CIJEVI "BENOTTO" <i>KLIN CEVI "BENOTTO"</i>	
47960	Ø 18 mm L-12 m	VRVNO OBESILO GRABILCA <i>ROAP PLUG FOR RAKE</i> UŽE SA GLAVOM ZA GRAJFER <i>UŽE SA GLAVOM ZA GRAJFER</i>	
47970	št. 31964	H KOS ZA GRABILEC <i>H PIECE FOR RAKE</i> H KOMAD ZA GRAJFER <i>H KOMAD ZA GRAJFER</i>	

KATALOG PRIBORA ZA VRTANJE
 Catalogue of drilling accessories

ŠIFRA CODE	SPECIFIKACIJA SPECIFICATION	NAZIV ARTIKLA PART DESCRIPTION	SLIKA / NAČRT PICTURE / DRAWING
SLO	REZERVNI DELI ZA ČRPALNI AGREGAT ČGZ-250		
ENG	BACKUP EQUIPMENT FOR PUMP CGZ-250		
CRO	REZERVNI DIJELOVI ZA CRPNI AGREGAT ČGZ-250		
SiCG	REZERVNI DELOVI ZA CRPNI AGREGAT ČGZ-250		
51001	Ø 85 mm	CILINDER CYLINDER CILINDAR CILINDAR	
51002	Ø 32 mm	BATNICA CONNECTION ROD KLIPNJAČA KLIPNJAČA	
51003	Ø 85 mm	BATNI VLOŽEK PISTON INSERTER KLIPNI ULOŽAK KLIPNI ULOŽAK	
51004	Ø 85 mm	MANSETA GASKET MANŽETNA MANŽETNA	
51005		SEDEŽ VENTILA VALVE SEAT SEDIŠTE VENTILA SEDIŠTE VENTILA	
51006	Ø 50 mm	KROGLA VENTILA BALL VALVE KUGLA VENTILA KUGLA VENTILA	
51007		KRIZNA GLAVA CROSSING HEAD UKRSNA GLAVA UKRSNA GLAVA	
51008		VARNOSTNI VENTIL SECURITY VALVE SIGURNOSNI VENTIL SIGURNOSNI VENTIL	
51009	M 24	MATICA	
51010	M 27	NUT NAVRTKA NAVRTKA	
51011	Ø 50 mm	SORNIK KRIZNE GLAVE CROSSED HEAD PIN SVORNJAK UKRSNE GLAVE SVORNJAK UKRSNE GLAVE	

KATALOG PRIBORA ZA VRTANJE
Catalogue of drilling accessories

ŠIFRA CODE	SPECIFIKACIJA SPECIFICATION	NAZIV ARTIKLA PART DESCRIPTION	SLIKA / NAČRT PICTURE / DRAWING
51012	Ø 50 mm	DRSNA PUŠA KRIŽNE GLAVE <i>SLIDING SPACER FOR CROSS HEAD</i> KLIZNA ČAURA UKRSNE GLAVE <i>KLIZNA ČAURA UKRSNE GLAVE</i>	
51013	Ø 32 mm	TESNILNI SET BATNICE <i>SEALS SET FOR CONNECTION ROD</i> BRTVILA-SET ZA KLIPOVE <i>BRTVILA-SET ZA KLIPOVE</i>	
51014		SESALNA KOSARA <i>SUCTION BASKET</i> USISNA KORPA <i>USISNA KORPA</i>	



ČRPALNI AGREGAT ČGZ-250
PUMP CGZ-250
CRPNI AGREGAT ČGZ-250
CRPNI AGREGAT ČGZ-250



Dimičeva 16, 1000 Ljubljana, SLOVENIJA

tel.: + 386 (0)1 2801 869

tel.: + 386 (0)1 2801 858

fax.: + 386 (0)1 2801 861

E-mail: komerciala@geostroj.si

www.geostroj.com